

DK ...
 Tapered diamond files
 Hardchromium
 Diamond length 50mm
 Total length 170mm

DK ...
 Konische Diamant Feilen
 Hartchrom
 Diamantlänge 50mm
 Gesamtlänge 170mm

DK ...
 Limes diamantées coniques
 Chromage dur
 Longueur diamantée 50mm
 Longueur totale 170mm

GRP
G11

FAM
106

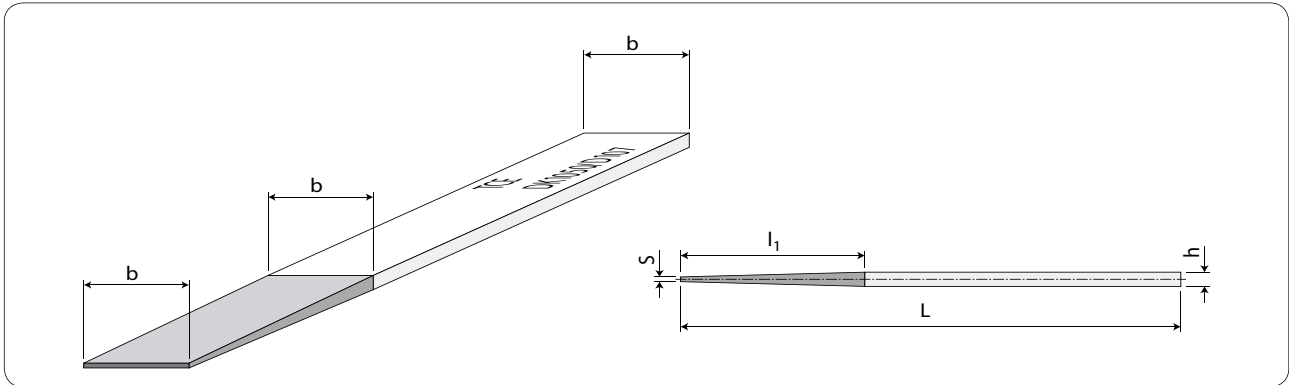
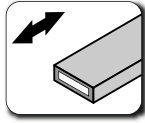

Item Nr.	Designation	b	S	h	l ₁	L	Fig.	D46	D76	D107	D126	D181
	Tapered / Konisch / Conique											
17.11 ...	DK 0450	4	0,3	2	50	170		...1227	...1228	...1229	...1230	...1231
17.11 ...	DK 0650	6	0,3	2	50	170		...1232	...1233	...1234	...1235	...1236
17.11 ...	DK 0850	8	0,3	2	50	170		...1237	...1238	...1239	...1240	...1241
17.11 ...	DK 1050	10	0,3	2	50	170		...1242	...1243	...1244	...1245	...1246

Ordering example :
 10 pcs DK 0450/D107 (Item number 17.11.1229)

*) Other grits are available upon request (20 pieces minimum order quantity) /
 Andere Körnungen sind auf Anfrage lieferbar (20 Stück Mindestbestellmenge) /
 Autres grains sont disponibles sur demande (20 pièces minimum)

NF ...
Diamond needle files
Hardchromium
Diamond length 70mm
Total length 140mm

NF ...
Diamant Nadelfeilen
Hartchrom
Diamantlänge 70mm
Gesamtlänge 140mm

NF ...
Limes aiguille diamantées
Chromage dur
Longueur diamantée 70mm
Longueur totale 140mm

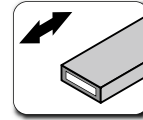

Item Nr.	Designation	b	h				Fig.	D46	D76	D107	D126	D181
	Pillar / Flachstumpf / Pilier											
17.11 ...	2112	5	1,4						...1001	...1002	...1003	...1004
17.11 ...	2112T	5	1,3						...1005	...1006	...1007	...1008
17.11 ...	2112T2	5	1,3							...1009		
17.11 ...	2112R	5	1,3						...1010	...1011	...1012	...1013
	Warding / Flachspitz / Entrée											
17.11 ...	2122	5	1,3						...1014	...1015	...1016	...1017
	Three square / Dreikant / Triangulaire											
17.11 ...	2132	3,5							...1018	...1019	...1020	...1021
17.11 ...	2132RT	3,5								...1022	...1023	
17.11 ...	2132T	3,5								...1024		
	2132TRT											
17.11 ...	2132TRT	3,5	1						...1025	...1026		

Ordering example :
10 pcs 2132TRT/D107 (Item number 17.11.1026)

*) Other grits are available upon request (20 pieces minimum order quantity) /
Andere Körnungen sind auf Anfrage lieferbar (20 Stück Mindestbestellmenge) /
Autres grains sont disponibles sur demande (20 pièces minimum)

NF ...
Diamond needle files
Hardchromium
Diamond length 70mm
Total length 140mm

NF ...
Diamant Nadelfeilen
Hartchrom
Diamantlänge 70mm
Gesamtlänge 140mm

NF ...
Limes aiguille diamantées
Chromage dur
Longueur diamantée 70mm
Longueur totale 140mm

GRP
G11

FAM
271

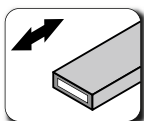

Item Nr.	Designation	b	h			Fig.	D46	D76	D107	D126	D181
	Square / Viereckig / Carrée										
17.11 ...	2142	2,7						...1027	...1028	...1029	...1030
17.11 ...	2142T3	2,7								...1030	
17.11 ...	2142RT	2,7							...1032		
17.11 ...	2142T2	2,7							...1033		
17.11 ...	2142T	2,7							...1034		
	Half round / Halbrund / Mironde										
17.11 ...	2152	5,4	1,8					...1035	...1036	...1037	...1038
17.11 ...	2152T	5,4	1,8						...1039	...1040	
	2152RT										
17.11 ...	2152R	5,4	1,8						...1041		
17.11 ...	2152RT	5,4	1,8						...1042		
	Round / Rund / Ronde										
17.11 ...	2162	3						...1043	...1044	...1045	...1046
17.11 ...	2162T	3							...1047	...1048	
	2162RT										
17.11 ...	2162RT	3	1						...1049		
17.11 ...	2162TRT	3	1						...1050		

NF ...
Diamond needle files
Hardchromium
Diamond length 70mm
Total length 140mm

NF ...
Diamant Nadelfeilen
Hartchrom
Diamantlänge 70mm
Gesamtlänge 140mm

NF ...
Limes aiguille diamantées
Chromage dur
Longueur diamantée 70mm
Longueur totale 140mm

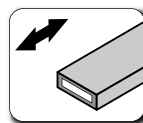

Item Nr.	Designation	b	h				Fig.	D46	D76	D107	D126	D181
	Knife / Messer / Couteau											
17.11 ...	2172	4,8	2						...1051	...1052	...1053	...1054
17.11 ...	2172T	4,8	2							...1055		
	Sword / Schwert / Épée											
17.11 ...	2182	4	2,5						...1056	...1057	...1058	...1059
	Crossing / Vogelzunge / Feuille de sauge											
17.11 ...	2192	4,7	2						...1060	...1061	...1062	...1063
17.11 ...	2192T	4,7	2							...1064		
	Barette / Barett / Barette											
17.11 ...	2102T	4,8	1,8						...1065	...1066	...1067	...1068
	2102RT											
17.11 ...	2102RT	4,8	1					...1069	...1070	...1071	...1072	...1073
	File set / Feilensatz / Jeux de limes											
17.11 ...	2000								...1247	...1248		...1249

Ordering example :
10 pcs 2102RT/D107 (Item number 17.11.1071)

*) Other grits are available upon request (20 pieces minimum order quantity) /
Andere Körnungen sind auf Anfrage lieferbar (20 Stück Mindestbestellmenge) /
Autres grains sont disponibles sur demande (20 pièces minimum)

NFE ...
 Extreme slim
 Diamond needle files
 Hardchromium
 Diamond length 70mm
 Total length 140mm

NFE ...
 Extrem schlank
 Diamant Nadelfeilen
 Hartchrom
 Diamantlänge 70mm
 Gesamtlänge 140mm

NFE ...
 Extrême effilé
 Limes aiguille diamantées
 Chromage dur
 Longueur diamantée 70mm
 Longueur totale 140mm

**GRP
G11**

**FAM
272**

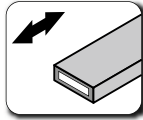

Item Nr.	Designation	b	h				Fig.	D46	D76	D107	D126	D181
	Pillar / Flachstumpf / Pilier											
17.11 ...	2812	5	1						...1074	...1075		
17.11 ...	2812T	5	1						...1076	...1077		
	Three square / Dreikant / Triangulaire											
17.11 ...	2832	2							...1078	...1079		
17.11 ...	2832RT	2							...1080	...1081		
17.11 ...	2832T	2							...1082	...1083		
	Square / Vierkant / Carrée											
17.11 ...	2842	2,75	2,75						...1084	...1085		
17.11 ...	2842T3	2,75	2,75						...1086	...1087		
17.11 ...	2842RT	2,75	2,75						...1088	...1089		
17.11 ...	2842T	2,75	2,75						...1090	...1091		
	Round / Rund / Ronde											
17.11 ...	2862	2,1							...1092	...1093		
17.11 ...	2862RT	2,1							...1094	...1095		
17.11 ...	2862TRT	2,1							...1096	...1097		

Ordering example :
 10 pcs 2862/D107 (Item number 17.11.1093)

*) Other grits are available upon request (20 pieces minimum order quantity) /
 Andere Körnungen sind auf Anfrage lieferbar (20 Stück Mindestbestellmenge) /
 Autres grains sont disponibles sur demande (20 pièces minimum)

HF ...
Diamond escapement files
Hardchromium

Diamond length 40mm
Total length 140mm

HF ...
Diamant Hemmungsfeilen
Hartchrom

Diamantlänge 40mm
Gesamtlänge 140mm

HF ...
Limes aux échappements
Diamantées
Chromage dur
Longueur diamantée 40 mm
Longueur totale 140mm

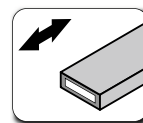

Item Nr.	Designation	b	h				Fig.	D46	D76	D107	D126	D181
	Pillar / Flachstumpf / Pilier											
17.11 ...	1740	4,1	1,1						...1098	...1099		
17.11 ...	1740T	4,1	1.1							...1100		
	Three square / Dreikant / Triangulaire											
17.11 ...	2040	2,6							...1101	...1102		
17.11 ...	2040RT	2,6								...1103		
17.11 ...	2040T	2,6								...1104		
	Square / Vierkant / Carrée											
17.11 ...	1440	1,8							...1105	...1106		
17.11 ...	1440T3	1,8								...1107		
17.11 ...	1440RT	1,8								...1108		
17.11 ...	1440T2	1,8								...1109		
17.11 ...	1440t	1,8								...1110		
	Half round / Halbrund / Mironde											
17.11 ...	1240	4,2	1,4							...1111		

Ordering example :
10 pcs 1440T/D107 (Item number 17.11.1110)

*) Other grits are available upon request (20 pieces minimum order quantity) /
Andere Körnungen sind auf Anfrage lieferbar (20 Stück Mindestbestellmenge) /
Autres grains sont disponibles sur demande (20 pièces minimum)

HF ...
Diamond escapement files
Hardchromium

Diamond length 40mm
Total length 140mm

HF ...
Diamant Hemmungsfeilen
Hartchrom

Diamantlänge 40mm
Gesamtlänge 140mm

HF ...
Limes aux échappements
Diamantées
Chromage dur
Longueur diamantée 40 mm
Longueur totale 140mm

GRP
G11

FAM
273

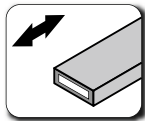

Item Nr.	Designation	b	h			Fig.	D46	D76	D107	D126	D181
	Round / Rund / Ronde										
17.11 ...	2140	1,8						...1112	...1113		
17.11 ...	2140T	1,8							...1114		
17.11 ...	2140RT	1,8							...1115		
17.11 ...	2140TRT	1,8							...1116		
	Barette / Barett / Barette										
17.11 ...	1140	4	1,2					...1117	...1118		
	1140RT										
17.11 ...	1140RT	4	1,2					...1119	...1120		
	Crossing / Vogelzunge / Feuille de sauge										
17.11 ...	1940	4	1,6					...1121			

Ordering example :

10 pcs 1140RT/D107 (Item number 17.11.1120)

*) Other grits are available upon request (30 pieces minimum order quantity) /
Andere Körnungen sind auf Anfrage lieferbar (30 Stück Mindestbestellmenge) /
Autres grains sont disponibles sur demande (30 pièces minimum)

FF ...
Diamond flat files
Hardchromium

FF ...
Flache Diamantfeilen
Hartchrom

FF ...
Limes plat diamantées
Chromage dur

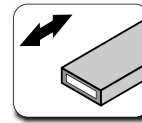

GRP
G11

FAM
274

Item Nr.	Designation	b	h	l ₁	L	l ₂	Fig.	D46	D76	D107	D126	D181
	Flat / Flach / Plate											
17.11 ...	1530E	15	1,5	30	100					...1122		...1112
17.11 ...	1540E	15	1,5	40	130					...1124		...1112
17.11 ...	1560E	15	1,5	60	190					...1126		...1112
17.11 ...	1570E	15	1,5	70	190							...1112
17.11 ...	0860A	8	1,6	60	190					...1129		
17.11 ...	1530A	15	1,6	30	100					...1130		...1131
17.11 ...	1540A	15	1,6	40	130					...1132		...1133
17.11 ...	1560A	15	1,6	60	190					...1134		...1135
17.11 ...	1580A	15	1,6	80	190					...1136		...1137
17.11 ...	19120A	19	4	120	205					...1138		
	Flat / Flach / Plate /											
17.11 ...	1580AM	15	1,6	190	190	30				...1139		...1140

Ordering example :

10 pcs 1580A/D107 (Item number 17.11.1136)

*) Other grits are available upon request (20 pieces minimum order quantity) /
Andere Körnungen sind auf Anfrage lieferbar (20 Stück Mindestbestellmenge) /
Autres grains sont disponibles sur demande (20 pièces minimum)

FFR ...
Diamond flat files
Hardchromium
With round handle 10mm

FFR ...
Flache Diamantfeilen
Hartchrom
Mit rundem Heft 10mm

FFR ...
Limes plat diamantées
Chromage dur
À manche ronde 10mm

GRP
G11

FAM
275

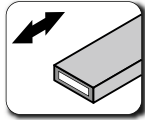

Item Nr.	Designation	b	h	l ₁	L	øD	Fig.	D46	D76	D107	D126	D181
	Flat / Flach / Plate											
17.11 ...	1050E	10	1,3	50	205	10				...1141	...1142	...1143
17.11 ...	1260SE	12	1,3	60	215	10				...1144	...1145	...1146
17.11 ...	1540SE	15	1,7	40	195	10				...1147	...1148	...1149
17.11 ...	1560SE	15	1,7	60	215	10				...1150	...1151	...1152
17.11 ...	1050SA	10	1,5	50	205	10				...1153	...1154	...1155
17.11 ...	1260SA	12	1,5	60	215	10				...1156	...1157	...1158
17.11 ...	1540SA	15	2,0	40	195	10				...1159	...1160	...1161
17.11 ...	1560SA	15	2,0	60	215	10				...1162	...1163	...1164

Ordering example :
10 pcs 1540SA/D107 (Item number 17.11.1159)









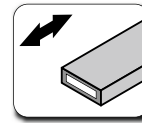

*) Other grits are available upon request (20 pieces minimum order quantity) /
Andere Körnungen sind auf Anfrage lieferbar (20 Stück Mindestbestellmenge) /
Autres grains sont disponibles sur demande (20 pièces minimum)

FFR3 ...
Diamond flat files
Hardchromium
With round handle 3mm

FFR3 ...
Flache Diamantfeilen
Hartchrom
Mit runden Heft 3mm

FFR3 ...
Limes plat diamantées
Chromage dur
À manche ronde 3mm



Item Nr.	Designation	b	h	l ₁	L	øD	Fig.	D46	D76	D107	D126	D181
	Flat / Flach / Plate											
17.11 ...	0835SE	8	1,2	35	75	3				...1165		...1166
17.11 ...	1035SE	10	1,2	35	75	3				...1167		...1168
17.11 ...	1235SE	12	1,2	35	75	3				...1169		...1170
17.11 ...	1535SE	15	1,2	35	75	3				...1171		...1172
17.11 ...	2035SA	20	1,2	35	75	3				...1173		...1174
17.11 ...	0835SA	8	1,4	35	75	3				...1175		...1176
17.11 ...	1035SA	10	1,4	35	75	3				...1177		...1178
17.11 ...	1235SA	12	1,4	35	75	3				...1179		...1180
17.11 ...	1535SA	15	1,4	35	75	3				...1181		...1182
17.11 ...	2035SA	20	1,4	35	75	3				...1183		...1184

Ordering example :
10 pcs 1535SA/D107 (Item number 17.11.1181)

*) Other grits are available upon request (20 pieces minimum order quantity) /
Andere Körnungen sind auf Anfrage lieferbar (20 Stück Mindestbestellmenge) /
Autres grains sont disponibles sur demande (20 pièces minimum)

HG ...
Diamond files
Hardchromium
Diamond length 105mm
Total length 215mm

HG ...
Diamant Feilen
Hartchrom
Diamantlänge 105mm
Gesamtlänge 215mm

HG ...
Limes diamantées
Chromage dur
Longueur diamantée 105mm
Longueur totale 215mm

**GRP
G11**

**FAM
277**

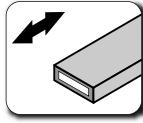

Item Nr.	Designation	b	h	l ₁	L	øD	Fig.	D46	D76	D107	D126	D181
	Flat / Flach / Plate											
17.11 ...	2612	10	3	105	215					...1185		...1186
	Three square / Dreikant / Triangulaire											
17.11 ...	2632	10		105	215					...1187		...1188
	Square / Vierkant / Carrée /											
17.11 ...	2642	6		105	215					...1189		...1190
	Half round / Halbrund / Demi ronde /											
17.11 ...	2652	13	4	105	215					...1191		...1192
	Round / Rund / Ronde /											
17.11 ...	2662	5		105	215					...1193		...1194
	File set / Feilensatz/ Jeux de limes											
17.11 ...	2600									...1195		...1196

Ordering example :
10 pcs 2652/D126 (Item number 17.11.1191)

*) Other grits are available upon request (5 pieces minimum order quantity) /
Andere Körnungen sind auf Anfrage lieferbar (5 Stück Mindestbestellmenge) /
Autres grains sont disponibles sur demande (5 pièces minimum)

DLE ...
Di-Profile Diamond files
Hardchromium
For handfile machines

DLE ...
Di-Profil Diamant Feilen
Hartchrom
Für Handfeilmaschinen

DLE ...
Di-Profil Limes diamantées
Chromage dur
Pour machines à main

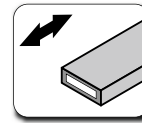

Item Nr.	Designation	b	h	l ₁	L	øD	Fig.	D46	D76	D107	D126	D181
	Flat / Flach / Plate											
17.11 ...	DLE 1	5,4	1,5	45	85	3				...1250		
17.11 ...	DLE 1T	5,4	1,4	45	85	3				...1251		
	Round / Rund / Ronde /											
17.11 ...	DLE 2S	0,7		45	85	2,3				...1256		
17.11 ...	DLE 2	2,4		45	85	3				...1252		
	Half round / Halbrund / Demi ronde /											
17.11 ...	DLE 3	5,2	1,8	45	85	3				...1253		
	Three square / Dreikant / Triangulaire											
17.11 ...	DLE 5	3,4		45	85	3				...1254		
	Square / Vierkant / Carrée											
17.11 ...	DLE 6	2,4		45	85	3				...1255		

Ordering example :
10 pcs DLE 6/D107 (Item number 17.11.1255)

*) Other grits are available upon request (30 pieces minimum order quantity) /
Andere Körnungen sind auf Anfrage lieferbar (30 Stück Mindestbestellmenge) /
Autres grains sont disponibles sur demande (30 pièces minimum)

FB ...
Diamond file bits
Hardchromium
For handfile machines

FB ...
Diamant Feilstiften
Hartchrom
Für Handfeilmaschinen

FB ...
Meules diamantées
Chromage dur
Pour machines à main

GRP
G11

FAM
279

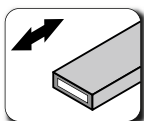

Item Nr.	Designation	ød ₁	l ₁	L	b	h	øD	Fig.	V	D76	D107
	Flat / Flach / Plate										
17.11 ...	301		15	50	2	1	3		5	...1197	...1198
17.11 ...	303		15	50	3	1	3		5	...1199	...1200
17.11 ...	305		15	50	4	1	3		5	...1201	...1202
17.11 ...	307		15	50	5	2	3		5	...1203	...1204
17.11 ...	309		25	60	5	2	3		5	...1205	...1206
17.11 ...	305A		15	50	4	1	3		5		...1207
	Round / Rund / Ronde /										
17.11 ...	331	1	15	50			3		5	...1208	...1209
17.11 ...	335	2	15	50			3		5	...1210	...1211
17.11 ...	337	2	25	60			3		5	...1212	...1213
17.11 ...	339	3	15	50			3		5	...1214	...1215
17.11 ...	343	3	25	60			3		5	...1216	...1217
17.11 ...	345	4	15	50			3		5	...1218	...1219
17.11 ...	347	4	25	60			3		5		...1220

Ordering example :

10 pcs 339/D107 (Item number 17.11.1215)

*) Other grits are available upon request (30 pieces minimum order quantity) /
Andere Körnungen sind auf Anfrage lieferbar (30 Stück Mindestbestellmenge) /
Autres grains sont disponibles sur demande (30 pièces minimum)







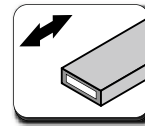

*) Please note the packing quantities under "V" (also minimum order quantities) /
Bitte beachten Sie die Verpackungsmengen in der Spalte "V" (gleich an Mindestbestellmengen) /
Faites attention aux quantités d'emballage indiquées à "V" (égal aux quantités de commande minimum)

FB ...
Diamond file bits
Hardchromium
For handfile machines

FB ...
Diamant Feilstiften
Hartchrom
Für Handfeilmaschinen

FB ...
Meules diamantées
Chromage dur
Pour machines à main



Item Nr.	Designation	∅d ₁	l ₁	L	b	h	∅D	Fig.	V	D76	D107
	Three square / Dreikant / Triangulaire										
											
17.11 ...	365		15	50			3		5		...1221
17.11 ...	367		15	50			3		5		...1222
17.11 ...	371		15	50			3		5		...1223
	Knife / Messer / Couteau										
											
17.11 ...	380		15	50			3		5		...1224
17.11 ...	382		15	50			3		5		...1225
	Square / Vierkant / Carrée										
											
17.11 ...	396		15	50					5		...1226

Ordering example :
10 pcs 365/D107 (Item number 17.11.1221)

- *) Other grits are available upon request (30 pieces minimum order quantity) /
Andere Körnungen sind auf Anfrage lieferbar (30 Stück Mindestbestellmenge) /
Autres grains sont disponibles sur demande (30 pièces minimum)
- *) Please note the packing quantities under "V" (also minimum order quantities) /
Bitte beachten Sie die Verpackungsmengen in der Spalte "V" (gleich an Mindestbestellmengen) /
Faites attention aux quantités d'emballage indiquées à "V" (égal aux quantités de commande minimum)

GB ...
Grinding bits
D-Hardchromium diamond
B-Cuboron

GB ...
Schleifstifte
D-Hartchrom Diamant
B-Borazon

GB ...
Meules
D-Diamant chromage dur
B-Borazon

GRP
G12

FAM
280

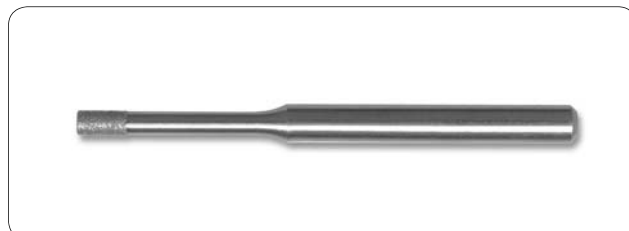
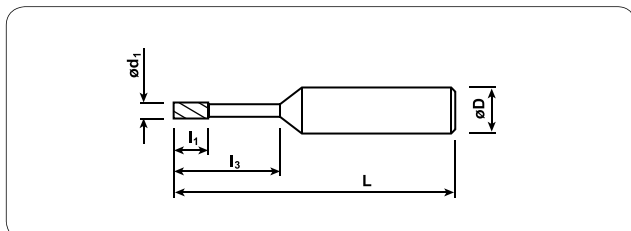
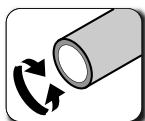

Item Nr.	Designation	$\varnothing d_1$	l_1	L	h	$\varnothing D$	V	D76	D107	D181	B76	B107	B181
17.12 ...	830	0,5	3	6	40	3	5	...1001			...1086		
17.12 ...	831	0,6	3	7	40	3	5	...1002			...1087		
17.12 ...	832	0,7	3	7	40	3	5	...1003	...1004		...1088	...1089	
17.12 ...	832L	0,7	7	9	40	3	5	...1005	...1006		...1090	...1091	
17.12 ...	833	0,8	3	7	40	3	5	...1007	...1008		...1092	...1093	
17.12 ...	833L	0,8	7	9	40	3	5	...1009	...1010		...1094	...1095	
17.12 ...	834	0,9	3	8	40	3	5	...1011	...1012		...1096	...1097	
17.12 ...	834L	0,9	8	10	40	3	5	...1013	...1014		...1098	...1099	
17.12 ...	835	1,0	3	8	40	3	5	...1015	...1016		...1100	...1101	
17.12 ...	835L	1,0	8	10	40	3	5	...1017	...1018		...1102	...1103	
17.12 ...	835XL	1,0	15	16	50	3	5	...1019	...1020		...1104	...1105	
17.12 ...	836	1,2	3	10	40	3	5	...1021	...1022		...1106	...1107	
17.12 ...	836L	1,2	10	12	40	3	5	...1023	...1024		...1108	...1109	
17.12 ...	836XL	1,2	15	16	50	3	5	...1025	...1026		...1110	...1111	
17.12 ...	837	1,5	4	12	40	3	5	...1027	...1028		...1112	...1113	
17.12 ...	837L	1,5	12	15	40	3	5	...1029	...1030		...1114	...1115	
17.12 ...	837XL	1,5	15	17	50	3	5	...1031	...1032		...1116	...1117	
17.12 ...	837XL2	1,5	25	26	60	3	5	...1033	...1034		...1118	...1119	
17.12 ...	838	1,8	4	12	40	3	5	...1035	...1036		...1120	...1121	
17.12 ...	838L	1,8	12	15	40	3	5	...1037	...1038		...1122	...1123	
17.12 ...	838XL	1,8	15	16	50	3	5	...1039	...1040		...1124	...1125	
17.12 ...	838XL2	1,8	25	26	60	3	5	...1041	...1042		...1126	...1127	
17.12 ...	839	2,0	4	14	40	3	5	...1043	...1044		...1128	...1129	
17.12 ...	839L	2,0	12	15	40	3	5	...1045	...1046		...1130	...1131	
17.12 ...	839XL	2,0	15	17	50	3	5	...1047	...1048		...1132	...1133	
17.12 ...	839XL2	2,0	25	26	60	3	5	...1049	...1050		...1134	...1135	
17.12 ...	840	2,5	4	17	40	3	5	...1051	...1052		...1136	...1137	
17.12 ...	840L	2,5	12	17	40	3	5	...1053	...1054		...1138	...1139	
17.12 ...	840XL	2,5	15	17	50	3	5	...1055	...1056		...1140	...1141	
17.12 ...	840XL2	2,5	25	26	60	3	5	...1057	...1058		...1142	...1143	
17.12 ...	841	3,0	5	18	40	3	5	...1059	...1060	...1061	...1144	...1145	...1146
17.12 ...	841L	3,0	12	18	40	3	5	...1062	...1063	...1064	...1147	...1148	...1149
17.12 ...	841XL	3,0	15	18	50	3	5	...1065	...1066	...1067	...1150	...1151	...1152
17.12 ...	841XL2	3,0	25	26	60	3	5	...1068	...1069	...1068	...1153	...1154	...1155
17.12 ...	841XL2-75	3,0	25	26	75	3	5		...1077	...1078			
17.12 ...	841XL2-100	3,0	25	26	100	3	5		...1079	...1080			
17.12 ...	842	3,5	5		40	3	5	...1071	...1072	...1073	...1156	...1157	...1158
17.12 ...	843	4,0	5		50	3	5	...1074	...1075	...1076	...1159	...1160	...1161
17.12 ...	843L	4,0	12		50	3	5	...1077	...1078	...1079	...1162	...1163	...1164
17.12 ...	843XL	4,0	15		60	3	5	...1080	...1081	...1082	...1165	...1166	...1167
17.12 ...	843XL2	4,0	25		60	3	5	...1083	...1084	...1085	...1168	...1169	...1170

Ordering example :

10 pcs 837XL/D76 (Item number 17.12.1031)

*) Other grits are available upon request (30 pieces minimum order quantity) /
Andere Körnungen sind auf Anfrage lieferbar (30 Stück Mindestbestellmenge) /
Autres grains sont disponibles sur demande (30 pièces minimum)



*) Please note the packing quantities under "V" (also minimum order quantities) /
Bitte beachten Sie die Verpackungsmengen in der Spalte "V" (gleich an Mindestbestimmungen) /
Faites attention aux quantités d'emballage indiquées à "V" (égal aux quantités de commande minimum)

DLG ...
Special grinding bits
Hard chromium Diamond
For grinding machines

DLG ...
Spezierschleifstifte
Hartchrom Diamant
Für Handschleifmaschinen

DLG ...
Meules diamantées spéciales
Diamant chromage dur
Pour machines à main



Item Nr.	Designation	d ₁	l ₁	L	D	R		D46	D76	D107	D126	D181
												
17.12 ...	DLG 2SE	0,5	20	60	3				...1182	...1183		
												
17.12 ...	DLG 2S1	0,5	45	85	2,8					...1291		
												
17.12 ...	DLG 841-R1.6	3,2	15	50	3	1,6			...1184	...1185		
17.12 ...	DLG 841L-R1.6	3,2	25	60	3	1,6			...1186	...1187		
17.12 ...	DLG 841XL-R1.6	3,2	25	75	3	1,6			...1188	...1189		

Ordering example :

10 pcs DLG 841L-R1.6/D107 (Item number 17.12.1186)

- *) Other grits are available upon request (30 pieces minimum order quantity) /
Andere Körnungen sind auf Anfrage lieferbar (30 Stück Mindestbestellmenge) /
Autres grains sont disponibles sur demande (30 pièces minimum)
- *) Please note the packing quantities under "V" (also minimum order quantities) /
Bitte beachten Sie die Verpackungsmengen in der Spalte "V" (gleich an Mindestbestellmengen) /
Faites attention aux quantités d'emballage indiqués à "V" (égal aux quantités de commande minimum)

LA ...
Needle files with round handles

LA ...
Nadelfeilen mit rundem
Stahlheft

LA ...
Limes aiguille à manches ronds

GRP
G15

FAM
297

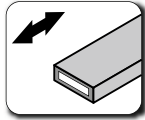

Item Nr.	Designation	L	Fig.	V	00	0	1	2	3	4
17.15 ...	LA 2401/100	100		12		...1006		...1001		
17.15 ...	LA 2401/140	140		12		...1007		...1002		
17.15 ...	LA 2401/160	160		12		...1008		...1003		
17.15 ...	LA 2401/180	180		12		...1009		...1004		
17.15 ...	LA 2401/200	200		12		...1010		...1005		
17.15 ...	LA 2402/100	100		12		...1016		...1011		
17.15 ...	LA 2402/140	140		12		...1017		...1012		
17.15 ...	LA 2402/160	160		12		...1018		...1013		
17.15 ...	LA 2402/180	180		12		...1019		...1014		
17.15 ...	LA 2402/200	200		12		...1020		...1015		
17.15 ...	LA 2403/100	100		12		...1026		...1021		
17.15 ...	LA 2403/140	140		12		...1027		...1022		
17.15 ...	LA 2403/160	160		12		...1028		...1023		
17.15 ...	LA 2403/180	180		12		...1029		...1024		
17.15 ...	LA 2403/200	200		12		...1030		...1025		
17.15 ...	LA 2405/100	100		12		...1036		...1031		
17.15 ...	LA 2405/140	140		12		...1037		...1032		
17.15 ...	LA 2405/160	160		12		...1038		...1033		
17.15 ...	LA 2405/180	180		12		...1039		...1034		
17.15 ...	LA 2405/200	200		12		...1040		...1035		

Ordering example :

24 pcs LA 2405/140/2 (Item number 17.15.1032)

*) Please note the packing quantities under "V" (also minimum order quantities) /
Bitte beachten Sie die Verpackungsmengen in der Spalte "V" (gleich an Mindestbestellmengen) /
Faites attention aux quantités d'emballage indiquées à "V" (égal aux quantités de commande minimum)

LA ...
Needle files with round handles

LA ...
Nadelfeilen mit rundem
Stahlheft

LA ...
Limes aiguille à manches rondes

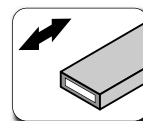

Item Nr.	Designation	L	Fig.	V	00	0	1	2	3	4
17.15 ...	LA 2406/100	100		12		...1046		...1041		
17.15 ...	LA 2406/140	140		12		...1047		...1042		
17.15 ...	LA 2406/160	160		12		...1048		...1043		
17.15 ...	LA 2406/180	180		12		...1049		...1044		
17.15 ...	LA 2406/200	200		12		...1050		...1045		
17.15 ...	LA 2407/100	100		12		...1056		...1051		
17.15 ...	LA 2407/140	140		12		...1057		...1052		
17.15 ...	LA 2407/160	160		12		...1058		...1053		
17.15 ...	LA 2407/180	180		12		...1059		...1054		
17.15 ...	LA 2407/200	200		12		...1060		...1055		
17.15 ...	LA 2408/100	100		12		...1066		...1061		
17.15 ...	LA 2408/140	140		12		...1067		...1062		
17.15 ...	LA 2408/160	160		12		...1068		...1063		
17.15 ...	LA 2408/180	180		12		...1069		...1064		
17.15 ...	LA 2408/200	200		12		...1070		...1065		
17.15 ...	LA 2409/100	100		12				...1071		
17.15 ...	LA 2409/140	140		12		...1077		...1072		
17.15 ...	LA 2409/160	160		12		...1078		...1073		
17.15 ...	LA 2409/180	180		12		...1079		...1074		
17.15 ...	LA 2409/200	200		12		...1080		...1075		

Ordering example :
24 pcs LA 2409/140/2 (Item number 17.15.1072)

*) Please note the packing quantities under "V" (also minimum order quantities) /
Bitte beachten Sie die Verpackungsmengen in der Spalte "V" (gleich an Mindestbestellmengen) /
Faites attention aux quantités d'emballage indiquées à "V" (égal aux quantités de commande minimum)

LA ...
Needle files with round handles

LA ...
Nadelfeilen mit rundem
Stahlheft

LA ...
Limes aiguille à manches ronds

GRP
G15

FAM
297

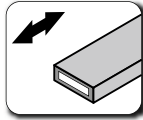

Item Nr.	Designation	L	Fig.	V	00	0	1	2	3	4
17.15 ...	LA 2410/100	100		12		...1086		...1081		
17.15 ...	LA 2410/140	140		12		...1087		...1082		
17.15 ...	LA 2410/160	160		12		...1088		...1083		
17.15 ...	LA 2410/180	180		12		...1089		...1084		
17.15 ...	LA 2410/200	200		12		...1090		...1085		
17.15 ...	LA 2411/100	100		12		...1096		...1091		
17.15 ...	LA 2411/140	140		12		...1097		...1092		
17.15 ...	LA 2411/160	160		12		...1098		...1093		
17.15 ...	LA 2411/180	180		12		...1099		...1094		
17.15 ...	LA 2411/200	200		12		...1100		...1095		
17.15 ...	LA 2415/140	140		12		...1104		...1101		
17.15 ...	LA 2415/160	160		12		...1105		...1102		
17.15 ...	LA 2415/180	180		12		...1106		...1103		
17.15 ...	LA 2416/140	140		12		...1110		...1107		
17.15 ...	LA 2416/160	160		12		...1111		...1108		
17.15 ...	LA 2416/180	180		12		...1112		...1109		

Ordering example :
24 pcs LA 2416/140/2 (Item number 17.15.1107)

*) Please note the packing quantities under "V" (also minimum order quantities) /
Bitte beachten Sie die Verpackungsmengen in der Spalte "V" (gleich an Mindestbestellmengen) /
Faites attention aux quantités d'emballage indiquées à "V" (égal aux quantités de commande minimum)

LE ...
Escapement files with square handle

LE ...
Hemmungsfeilen mit viereckigem Stahlheft

LE ...
Limes aux échappements à manche carrée

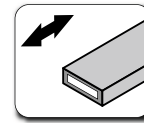

GRP
G15

FAM
310



Item Nr.	Designation	L	Fig.	V	00	0	1	2	3	4
17.15 ...	LE 3004/55	55		12			...1113			
17.15 ...	LE 3008/40	40		12			...1114			
17.15 ...	LE 3008/55	55		12			...1115			
17.15 ...	LE 3009/40	40		12			...1116			
17.15 ...	LE 3009/55	55		12			...1117			
17.15 ...	LE 3010/40	40		12			...1118			
17.15 ...	LE 3010/55	55		12			...1119			
17.15 ...	LE 3014/40	40		12			...1120			
17.15 ...	LE 3014/55	55		12			...1121			
17.15 ...	LE 3016/55	55		12			...1122			
17.15 ...	LE 3017/55	55		12			...1123			
17.15 ...	LE 3017/65	65		12			...1124			
17.15 ...	LE 3020/55	55		12			...1125			
17.15 ...	LE 3020/65	65		12			...1126			
17.15 ...	LE 3021/55	55		12			...1127			
17.15 ...	LE 3021/65	65		12			...1128			

Ordering example :
24 pcs LE 3021/55/2 (Item number 17.15.1126)

*) Please note the packing quantities under "V" (also minimum order quantities) /
Bitte beachten Sie die Verpackungsmengen in der Spalte "V" (gleich an Mindestbestellmengen) /
Faites attention aux quantités d'emballage indiquées à "V" (égal aux quantités de commande minimum)