

ZY
 Mounted points
 According to DIN69170
 Cylindrical shape
 Ceramic bonds

ZY
 Schleifstifte
 Nach DIN69170
 Zylinderform
 Keramische Bindung

ZY
 Meules sur tige cylindriques
 Selon DIN69170
 Forme cylindrique
 Liant céramique

GRP
H11

FAM
236

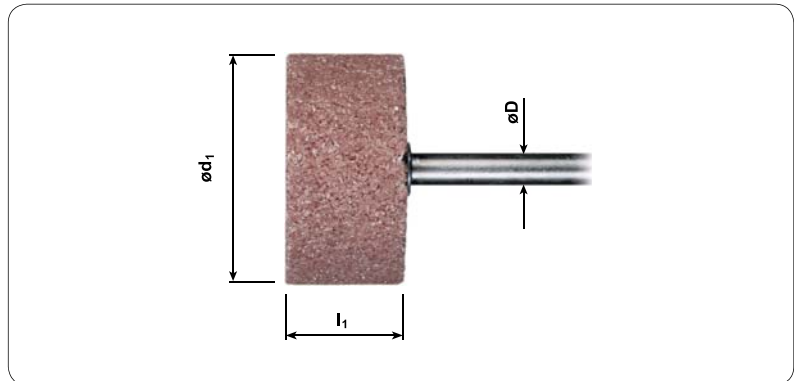
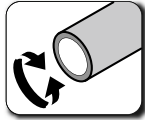

Item Nr.	Designation	ød ₁	l ₁	øD	V	K24	K30	K46	K60	K80	K100
18.11 ...	ZY 0205.3	2	5	3	10						...1054
18.11 ...	ZY 0205.6	2	5	6	10						...1055
18.11 ...	ZY 0306.3	3	6	3	10						...1056
18.11 ...	ZY 0306.6	3	6	6	10						...1057
18.11 ...	ZY 0402.3	4	2	3	10						...1058
18.11 ...	ZY 0408.3	4	8	3	10				...1131		...1059
18.11 ...	ZY 0408.6	4	8	6	10				...1132		...1060
18.11 ...	ZY 0510.3	5	10	3	10				...1133		...1061
18.11 ...	ZY 0510.6	5	10	6	10				...1134		...1062
18.11 ...	ZY 0515.3	5	15	3	10				...1135		
18.11 ...	ZY 0613.3	6	13	3	10				...1136		
18.11 ...	ZY 0613.6	6	13	6	10				...1137		...1064
18.11 ...	ZY 0625.3	6	25	3	10				...1138		
18.11 ...	ZY 0625.6	6	25	6	10				...1139		
18.11 ...	ZY 0802.3	8	2	3	10						...1065
18.11 ...	ZY 0802.6	8	2	6	10						
18.11 ...	ZY 0804.6	8	4	6	10						
18.11 ...	ZY 0810.3	8	10	3	10			...1102		...1161	
18.11 ...	ZY 0810.6	8	10	6	10			...1103		...1162	
18.11 ...	ZY 0816.3	8	16	3	10			...1104		...1163	
18.11 ...	ZY 0816.6	8	16	6	10			...1105			
18.11 ...	ZY 1002.3	10	2	3	10						...1067
18.11 ...	ZY 1002.6	10	2	6	10						...1068
18.11 ...	ZY 1005.6	10	5	6	10						
18.11 ...	ZY 1013.3	10	13	3	10			...1107		...1164	
18.11 ...	ZY 1013.6	10	13	6	10			...1108		...1165	
18.11 ...	ZY 1020.6	10	20	6	10			...1109		...1166	
18.11 ...	ZY 1025.6	10	25	6	10			...1110		...1167	
18.11 ...	ZY 1032.6	10	32	6	10			...1111		...1168	
18.11 ...	ZY 1303.3	13	3	3	10				...1140		...1069
18.11 ...	ZY 1303.6	13	3	6	10				...1141		...1070
18.11 ...	ZY 1306.6	13	6	6	10			...1112			
18.11 ...	ZY 1313.3	13	13	3	10			...1113		...1169	
18.11 ...	ZY 1313.6	13	13	6	10			...1114		...1170	
18.11 ...	ZY 1320.6	13	20	6	10			...1115		...1171	
18.11 ...	ZY 1325.6	13	25	6	10			...1116		...1172	
18.11 ...	ZY 1340.6	13	40	6	10			...1117			
18.11 ...	ZY 1604.3	16	4	3	10			...1118		...1173	
18.11 ...	ZY 1604.6	16	4	6	10			...1119		...1174	
18.11 ...	ZY 1608.6	16	8	6	10						
18.11 ...	ZY 1610.6	16	10	6	10		...1079				
18.11 ...	ZY 1620.6	16	20	6	10		...1080		...1142		
18.11 ...	ZY 1632.6	16	32	6	10		...1081		...1143		
18.11 ...	ZY 1640.6	16	40	6	10		...1082		...1144		
18.11 ...	ZY 1650.6	16	50	6	10		...1083				
18.11 ...	ZY 2006.6	20	6	3	10			...1120		...1175	

ZY

Mounted points
According to DIN69170
Cylindrical shape
Ceramic bonds

ZY

Schleifstifte
Nach DIN69170
Zylinderform
Keramische Bindung

ZY

Meules sur tige cylindriques
Selon DIN69170
Forme cylindrique
Liant céramique

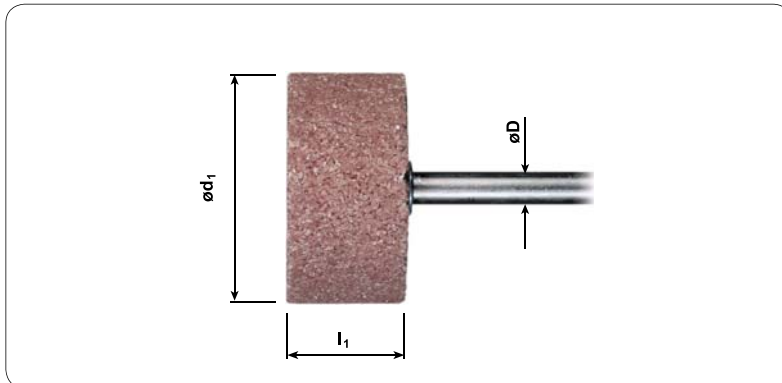

Item Nr.	Designation	$\varnothing d_1$	l_1	$\varnothing D$	V	K24	K30	K46	K60	K80	K100
18.11 ...	ZY 2006.6	20	6	6	10			...1121		...1176	
18.11 ...	ZY 2010.6	20	10	6	10		...1084		...1146		
18.11 ...	ZY 2013.6	20	13	6	10		...1085				
18.11 ...	ZY 2020.6	20	20	6	10		...1086		...1147		
18.11 ...	ZY 2025.6	20	25	6	10		...1087		...1148		
18.11 ...	ZY 2032.6	20	32	6	10		...1088		...1149		
18.11 ...	ZY 2040.6	20	40	6	10		...1089		...1150		
18.11 ...	ZY 2050.6	20	50	6	10		...1090				
18.11 ...	ZY 2506.6	25	6	6	10			...1122		...1177	
18.11 ...	ZY 2510.6	25	10	6	10		...1091		...1151		
18.11 ...	ZY 2513.6	25	13	6	10		...1092				
18.11 ...	ZY 2516.6	25	16	6	10				...1153		
18.11 ...	ZY 2525.6	25	25	6	10		...1094		...1154		
18.11 ...	ZY 2532.6	25	32	6	10		...1095		...1155		
18.11 ...	ZY 2540.6	25	40	6	10		...1096				
18.11 ...	ZY 3208.6	32	8	6	5		...1097		...1156		
18.11 ...	ZY 3216.6	32	16	6	5	...1071		...1123			
18.11 ...	ZY 3220.6	32	20	6	5	...1072		...1124			
18.11 ...	ZY 3240.6	32	32	6	5	...1073		...1125			
18.11 ...	ZY 4006.6	40	40	6	5	...1074		...1126			
18.11 ...	ZY 4010.6	40	6	6	5			...1127			
18.11 ...	ZY 4015.6	40	10	6	5		...1098		...1157		
18.11 ...	ZY 4015.6	40	15	6	5		...1099		...1158		
18.11 ...	ZY 4020.6	40	20	6	5	...1075		...1128			
18.11 ...	ZY 4040.6	40	40	6	5	...1076		...1129			
18.11 ...	ZY 5008.6	50	8	6	5		...1100				
18.11 ...	ZY 5013.6	50	13	6	5		...1101		...1159		
18.11 ...	ZY 5025.6	50	25	6	5	...1077		...1130			

Ordering example :

2 pcs ZY 4015.6 K30 (Item number 18.11.1099)

*) Please note the packing quantities indicated under "V"

For example: when ordering 50 pcs of "ZY 2506.6 K30", you will receive 5 packages of 10 pcs each.
Minimum order quantities are equal to the packing quantity

Bitte beachten Sie die Mengen je Verpackung in der Spalte "V"

Zum Beispiel : wenn Sie 50 Stück "ZY 2506.6 K30" bestellen, erhalten Sie 5 Verpackungen à 10 Stück
Die Minimalmengen sind jeweils die Verpackungsmengen

Faites attention aux quantités d'emballage, indiqué à "V"

Par exemple: si vous commandez 50 pièces de "ZY 2506.6 K30", vous recevrez 5 emballages à 10 pièces
Les quantités de commande minimum sont équivalentes aux quantités d'emballage

*) Other grits, sizes and/or types are available upon request /

Andere Körnungen, Massen und/oder Typen sind auf Anfrage lieferbar /
Autres grains, dimensions et/ou types sont disponibles sur demande

PF
Polishing points
Pink

PF
Feinstschleifstifte
Rosa

PF
Meules de polissage
Rose

GRP
H11

FAM
237

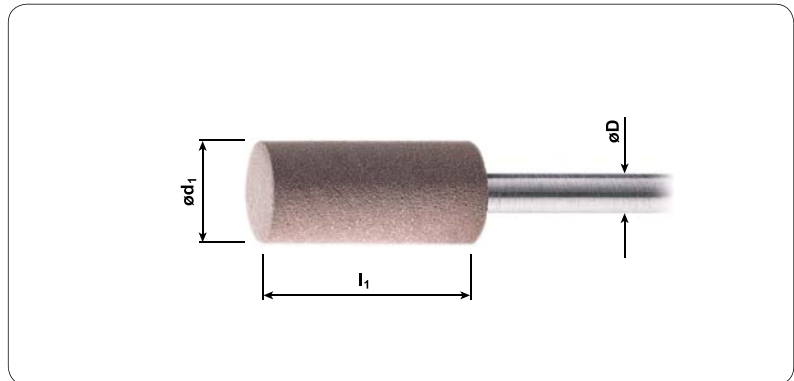
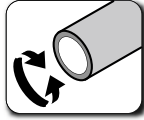

Item Nr.	Designation	$\varnothing d_1$	l_1	$\varnothing D$	V	K46	K80	K120	K220
18.11 ...	PF 0408.3	4	8	3	10			...1001	
18.11 ...	PF 0610.3	6	10	3	10			...1002	
18.11 ...	PF 0808.3	8	8	3	10			...1003	...1029
18.11 ...	PF 0812.3	8	12	3	10			...1004	...1030
18.11 ...	PF 1006.3	10	6	3	10			...1005	...1031
18.11 ...	PF 1006.6	10	6	6	10				
18.11 ...	PF 1010.3	10	10	3	10			...1007	...1032
18.11 ...	PF 1010.6	10	10	6	10			...1008	
18.11 ...	PF 1015.3	10	15	3	10			...1009	...1033
18.11 ...	PF 1015.6	10	15	6	10			...1010	...1034
18.11 ...	PF 1025.6	10	25	6	10	...1046	...1050	...1011	...1035
18.11 ...	PF 1208.3	12	8	3	10			...1012	
18.11 ...	PF 1208.6	12	8	6	10			...1013	
18.11 ...	PF 1212.3	12	12	3	10			...1014	
18.11 ...	PF 1212.6	12	12	6	10			...1015	...1036
18.11 ...	PF 1220.3	12	20	3	10			...1016	...1037
18.11 ...	PF 1220.6	12	20	6	10			...1017	...1038
18.11 ...	PF 1510.6	15	12	6	10				
18.11 ...	PF 1515.6	15	15	6	10			...1019	...1039
18.11 ...	PF 1525.6	15	25	6	10			...1020	...1040
18.11 ...	PF 1530.6	15	30	6	10	...1047	...1051	...1021	...1041
18.11 ...	PF 2012.6	20	12	6	10			...1022	...1042
18.11 ...	PF 2020.6	20	20	6	10			...1023	...1043
18.11 ...	PF 2030.6	20	30	6	10	...1048	...1052	...1024	
18.11 ...	PF 2515.6	25	15	6	10			...1025	
18.11 ...	PF 2525.6	25	25	6	10			...1026	...1044
18.11 ...	PF 3020.6	30	20	6	5			...1027	
18.11 ...	PF 3030.6	30	30	6	5	...1049	...1053	...1028	...1045

Ordering example :

2 pcs ZY 4015.6 K30 (Item number 18.11.1099)

*) Please note the packing quantities indicated under "V"

For example: when ordering 50 pcs of "PF 2030.6 K120", you will receive 5 packages of 10 pcs each.
Minimum order quantities are equal to the packing quantity

Bitte beachten Sie die Mengen je Verpackung in der Spalte "V"

Zum Beispiel : wenn Sie 50 Stück "PF 2030.6 K120" bestellen, erhalten Sie 5 Verpackungen à 10 Stück
Die Minimalmengen sind jeweils die Verpackungsmengen

Faites attention aux quantités d'emballage, indiqué à "V"

Par exemple: si vous commandez 50 pièces de "PF 2030.6 K120", vous recevrez 5 emballages à 10 pièces
Les quantités de commande minimum sont équivalent aux quantités d'emballage

*) Other grits, sizes and/or types are available upon request /

Andere Körnungen, Massen und/oder Typen sind auf Anfrage lieferbar /
Autres grains, dimensions et/ou types sont disponibles sur demande

KSB / GSB

Abrasive spiral bands
 "KSB" in small pack
 "GSB" in bulk pack

KSB/ GSB

Schleifbänder
 "KSB" in Kleinpack
 "GSB" in Grosspack

KSB / GSB

Bandes abrasives
 "KSB" en petit emballage
 "GSB" en grand emballage



KSB

GSB

Item Nr.	Designation	ød ₁	l ₁	V	K46	K80	K120	K220	K80	K100
	KSB									
18.11 ...	KSB 0410	4	10	25					...1195	
18.11 ...	KSB 0610	6	10	25					...1196	
18.11 ...	KSB 0810	8	10	25					...1197	
18.11 ...	KSB 1010	10	10	25				...1198	...1199	
18.11 ...	KSB 1020	10	20	25				...1200	...1201	...1202
18.11 ...	KSB 1310	13	10	25				...1203	...1204	
18.11 ...	KSB 1325	13	25	25				...1205	...1206	
18.11 ...	KSB 1510	15	10	25			...1207	...1208	...1209	
18.11 ...	KSB 1530	15	30	25		...1210	...1211	...1212	...1213	...1214
18.11 ...	KSB 1925	19	25	25			...1215	...1216	...1217	...1218
18.11 ...	KSB 2220	22	20	25		...1219	...1220	...1221	...1222	...1223
18.11 ...	KSB 2525	25	25	25			...1224	...1225	...1226	...1227
18.11 ...	KSB 3020	30	20	25	...1228		...1229	...1230	...1231	
18.11 ...	KSB 3030	30	30	25	...1229	...1232	...1234	...1235	...1236	...1237
	GSB									
18.11 ...	GSB 0410	4	10	1.000					...1238	
18.11 ...	GSB 0610	6	10	1.000					...1239	
18.11 ...	GSB 0810	8	10	1.000					...1240	
18.11 ...	GSB 1010	10	10	1.000				...1241	...1242	
18.11 ...	GSB 1020	10	20	1.000				...1243	...1244	...1254
18.11 ...	GSB 1310	13	10	1.000				...1246	...1247	
18.11 ...	GSB 1325	13	25	1.000				...1248	...1249	...1250
18.11 ...	GSB 1510	15	10	1.000			...1251	...1252	...1253	...1254
18.11 ...	GSB 1530	15	30	1.000		...1255	...1256	...1257	...1258	...1259
18.11 ...	GSB 1925	19	25	1.000			...1260	...1261	...1262	
18.11 ...	GSB 2220	22	20	1.000		...1263	...1264	...1265	...1266	...1267
18.11 ...	GSB 2525	25	25	1.000			...1268	...1269	...1270	
18.11 ...	GSB 3020	30	20	1.000	...1271		...1272	...1273	...1274	...1275
18.11 ...	GSB 3030	30	30	1.000	...1277	...1276	...1278	...1279	...1280	...1281

Ordering example 1 :

1.000 pcs KSB 1325 K80 (Item number 18.11.1205)

You will receive 40 packages of 25 pcs each / Sie erhalten 40 Verpackungen à 25 Stück / Vous recevrez 40 emballages à 25 pièces

Ordering example 1 :

1.000 pcs GSB 1325 K80 (Item number 18.11.1248)

You will receive 1 package of 1.000 pcs each / Sie erhalten 1 Verpackung à 1.000 Stück / Vous recevrez 1 emballage à 1.000 pièces

*) Minimum order quantities are equal to the packing quantity /
 Die Minimalmengen sind jeweils die Verpackungsmengen /
 Les quantités de commande minimum sont équivalentes aux quantités d'emballage

*) Other grits, sizes and/or types are available upon request /
 Andere Körnungen, Massen und/oder Typen sind auf Anfrage lieferbar /
 Autres grains, dimensions et/ou types sont disponibles sur demande

GK
Rubber drum holders

GK
Schleifbandkörper

GK
Supports caoutchouc

GRP
H11

FAM
286

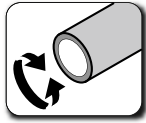

Item Nr.	Designation	$\varnothing d_1$	l_1	$\varnothing D$	V								
18.11.1178	GK 0410.3	4	10	3	5								
18.11.1179	GK 0410.6	4	10	6	5								
18.11.1180	GK 0610.3	6	10	3	5								
18.11.1181	GK 0610.6	6	10	6	5								
18.11.1182	GK 0810.3	8	10	3	5								
18.11.1183	GK 0810.6	8	10	6	5								
18.11.1184	GK 1010.6	10	10	6	5								
18.11.1185	GK 1020.6	10	20	6	5								
18.11.1186	GK 1310.6	13	10	6	5								
18.11.1187	GK 1325.6	13	25	6	5								
18.11.1188	GK 1510.6	15	10	6	5								
18.11.1189	GK 1530.6	15	30	6	5								
18.11.1190	GK 1925.6	19	25	6	5								
18.11.1191	GK 2220.6	22	20	6	5								
18.11.1192	GK 2525.6	25	25	6	5								
18.11.1193	GK 3020.6	30	20	6	5								
18.11.1194	GK 3030.6	30	30	6	5								

Ordering example :
5 pcs GK 1510.6 (Item number 18.11.1188)

*) V = Packing quantity /
V = Verpackungsmenge /
V = Quantité d'emballage

SF / SM
 Abrasive discs & holders
 Metal screw connection

SF / SM
 Schleifblätter & Halter
 Metall Schraubverbindung

SF / SM
 Pastilles & supports
 Assemblage de tayaux à vis

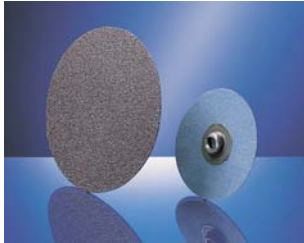

Type "SF"



Type "SM"



Item Nr.	Designation	ød ₁	øD	V	K36	K60	K80	K120	K180	K320
	Abrasive discs / Schleifblätter / Pastilles abrasives									
18.11 ...	SF 20	20		100		...1282	...1283	...1284	...1285	...1286
18.11 ...	SF 25	25		100		...1287	...1288	...1289	...1290	...1291
18.11 ...	SF 38	38		100	...1292	...1293	...1294	...1295	...1296	...1297
18.11 ...	SF 50	50		100	...1298	...1299	...1300	...1301	...1302	...1303
	Carriers / Träger / Portes									
18.11.1304	SM 20	20	6	1						
18.11.1305	SM 25	25	6	1						
18.11.1306	SM 38	38	6	1						
18.11.1307	SM 50	50	6	1						

Ordering example :
 500 pcs SF 20 K60 (Item number 18.11.1282)

*) V = Packing quantity /
 V = Verpackungsmenge /
 V = Quantité d'emballage

SBR / SRH
Economy rolls & holders

SBR / SRH
Sparrollen & Halter

SBR / SRH
Rouleaux d'atelier & supports

GRP
H11

FAM
288

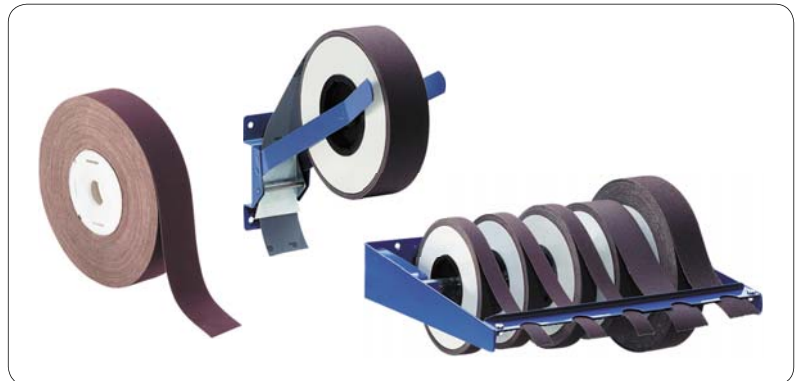
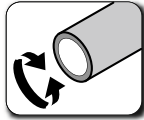

Item Nr.	Designation	B	øD _{MAX}	K60	K80	K120	K150	K180	K240	K320	K400
	Economy rolls / Sparrollen / Rouleaux d'atelier										
18.11 ...	SBR 25	25	244	...1308	...1309	...1310	...1311	...1312	...1313	...1314	...1315
18.11 ...	SBR 38	38	244	...1489	...1490	...1491	...1492	...1493	...1494	...1495	...1496
18.11 ...	SBR 40	40	244	...1497	...1498	...1499	...1500	...1501	...1502	...1503	...1504
18.11 ...	SBR 50	50	244	...1316	...1317	...1318	...1319	...1320	...1321	...1322	...1323
	Holders for economy rolls / Halter für Sparrollen / Supports pour des rouleaux										
18.11.1324	SRH 1		380								
18.11.1325	SRH 5		260								

Ordering example :
5 pcs SBR 50 K60 (Item number 18.11.1316)

FS
Fan grinders
According to DIN69183

FS
Fächerschleifer
Nach DIN69183

FS
Roues à lamelles
Selon DIN69183

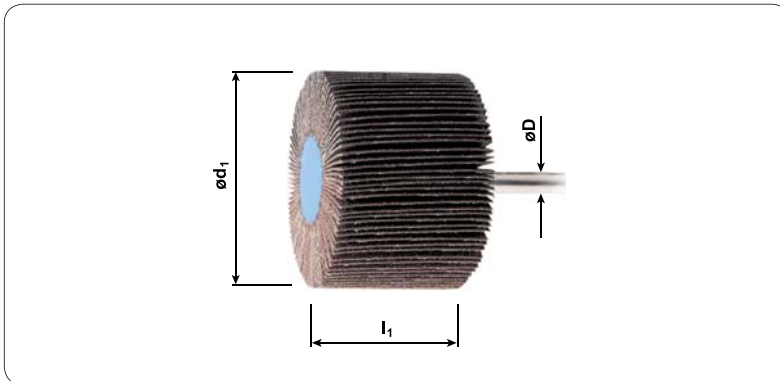

GRP
H11

FAM
287

Item Nr.	Designation	ød ₁	l ₁	øD	V	K60	K80	K120	K150	K180	K240
18.11 ...	FS 2010.3	20	10	3	10			...1326	...1327	...1328	
18.11 ...	FS 2010.6	20	10	6	10		...1329	...1330	...1331	...1332	
18.11 ...	FS 2510.6	25	10	6	10		...1333	...1334	...1335	...1336	
18.11 ...	FS 2515.6	25	15	6	10		...1336	...1337	...1338	...1339	
18.11 ...	FS 2520.6	25	20	6	10		...1340	...1341	...1342	...1343	
18.11 ...	FS 2525.6	25	25	6	10		...1343	...1344	...1345	...1346	
18.11 ...	FS 3005.3	30	5	3	10	...1347	...1348	...1349	...1350	...1351	...1352
18.11 ...	FS 3005.6	30	5	6	10	...1353	...1354	...1355	...1356	...1357	...1358
18.11 ...	FS 3010.3	30	10	3	10	...1359	...1360	...1361	...1362	...1363	...1364
18.11 ...	FS 3010.6	30	10	6	10	...1365	...1366	...1367	...1368	...1369	...1370
18.11 ...	FS 3015.6	30	15	6	10	...1371	...1372	...1373	...1374	...1375	...1376
18.11 ...	FS 3030.6	30	30	6	10	...1377	...1378	...1379	...1380	...1381	...1382
18.11 ...	FS 4010.6	40	10	6	10	...1383	...1384	...1385	...1386	...1387	...1388
18.11 ...	FS 4015.6	40	15	6	10	...1389	...1390	...1391	...1392	...1393	...1394
18.11 ...	FS 4020.6	40	20	6	10	...1395	...1396	...1397	...1398	...1399	...1400
18.11 ...	FS 5010.6	50	10	6	10	...1401	...1402	...1403	...1404	...1405	...1406
18.11 ...	FS 5015.6	50	15	6	10	...1407	...1408	...1409	...1410	...1411	...1412
18.11 ...	FS 5020.6	50	20	6	10	...1413	...1414	...1415	...1416	...1417	
18.11 ...	FS 5030.6	50	30	6	10	...1418	...1419	...1420	...1421	...1422	...1423

Ordering example :
10 pcs FS 2525.6 K80 (Item number 18.11.1343)

*) V = Packing quantity /
V = Verpackungsmenge /
V = Quantité d'emballage

DW
Polishing points

For high-gloss polishing

DW
Feinstschleifstifte

Zum Hochglanzpolieren

DW
Meules de polissage

Pour polissage glacer

GRP
H11

FAM
251

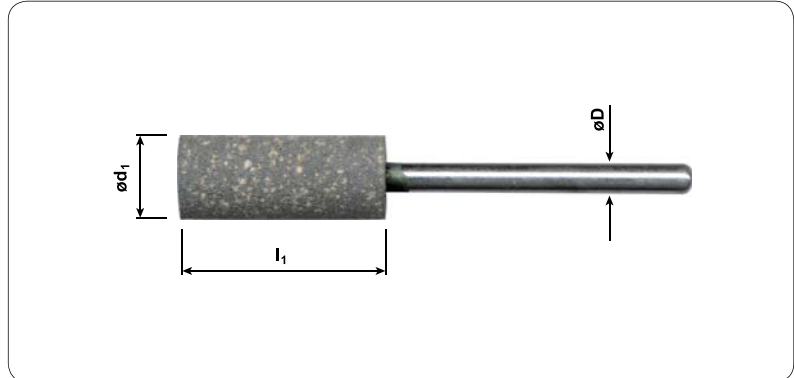
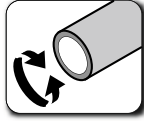

Item Nr.	Designation	$\varnothing d_1$	l_1	L	$\varnothing D$	V	K120	K180
18.11 ...	DW 0205	2	5	45	3	5	...1424	...1425
18.11 ...	DW 0308	3	8	35	3	5	...1426	...1427
18.11 ...	DW 0413	4	13	43	3	5	...1428	...1429
18.11 ...	DW 0515	5	15	45	3	5	...1430	...1431
18.11 ...	DW 0617	6	17	47	3	5	...1432	...1433
18.11 ...	DW 0820	8	20	50	3	5	...1434	...1435
18.11 ...	DW 1020	10	20	50	3	5	...1436	...1437
18.11 ...	DW 1320	13	20	50	3	5	...1438	...1439
18.11 ...	DW 1520	15	20	50	3	5	...1440	...1441
18.11 ...	DW 2025	20	25	60	6	5	...1442	...1443
18.11 ...	DW 2525	25	25	60	6	5	...1444	...1445

Ordering example :

5 pcs DW 1520 K120 (Item number 18.11.1440)

*) V = Packing quantity /
V = Verpackungsmenge /
V = Quantité d'emballage

PC / PCT

Abrasive caps & Holders
 Type "A" is cylinder shape
 Type "C" is cylinder shape with radius end

PC / PCT

Schleifkappen & Träger
 Form "A", Zylinder
 Form "C", Walzenrundform

PC / PCT

Capuchons abras. & supports
 Forme "A", cylindrique
 Forme "C", cylindrique à bout

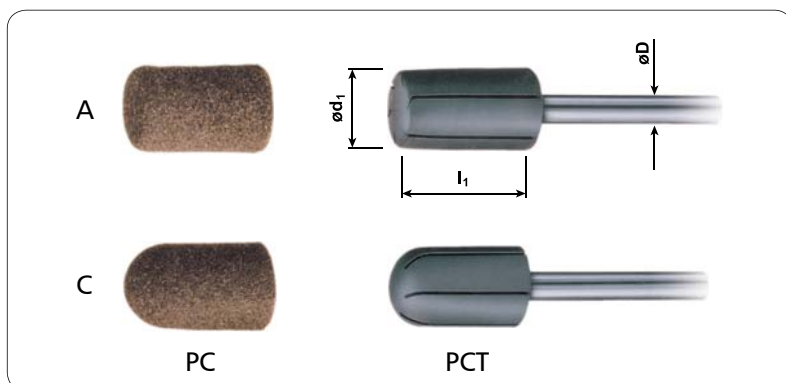

GRP
H11

FAM
306

Item Nr.	Designation	ød ₁	l ₁	øD	V	K46	K80	K120	K220
	Abrasive caps / Schleifkappen / Capuchons abrasifs								
18.11 ...	PC 05 A	5			50		...1446	...1447	...1448
18.11 ...	PC 07 A	7			50	...1449		...1450	...1451
18.11 ...	PC 10 A	10			50	...1452		...1453	...1454
18.11 ...	PC 13 A	13			50	...1455		...1456	...1457
18.11 ...	PC 16 A	16			50	...1458		...1459	...1460
18.11 ...	PC 05 C	5			50		...1461	...1462	...1463
18.11 ...	PC 07 C	7			50	...1464		...1465	...1466
18.11 ...	PC 10 C	10			50	...1467		...1468	...1469
18.11 ...	PC 13 C	13			50	...1470		...1471	...1472
18.11 ...	PC 16 C	16			50	...1473		...1474	...1475
	Carriers / Träger / Portes								
18.11.1476	PCT 0510 A 3	5	10						
18.11.1477	PCT 0712 A 3	7	12						
18.11.1478	PCT 1015 A 3	10	15						
18.11.1479	PCT 1317 A 6	13	17						
18.11.1480	PCT 1626 A 6	16	26						
18.11.1481	PCT 0511 C 3	5	11						
18.11.1482	PCT 0713 C 3	7	13						
18.11.1483	PCT 1015 C 3	10	15						
18.11.1484	PCT 1317 C 6	13	17						
18.11.1485	PCT 1626 C 6	16	26						

Ordering example :

50 pcs PC 10 C K60 (Item number 18.11.1467)

*) V = Packing quantity /
 V = Verpackungsmenge /
 V = Quantité d'emballage

KS ...
Ceramic Polishing sticks

For high-gloss polishing

KS ...
Keramische Polierstäbe

Zum Hochglanzpolieren

KS ...
Barreau de polissage céramique

Pour polissage glacer

GRP
H11

FAM
319

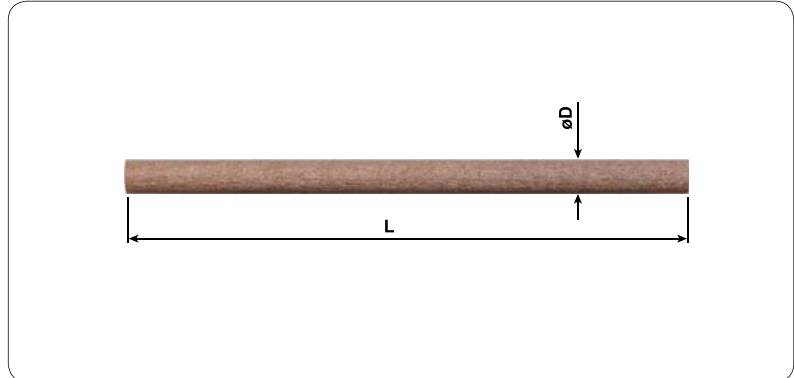
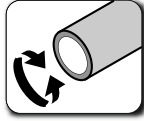

Item Nr.	Designation	ød	l ₁	V	K18	K300	K400	K600	K800	K1000	K1200
18.11 ...	KS 03030	25	244				...1486				
18.11 ...	KS 03050	38	244				...1487				
18.11 ...	KS 03100	50	244				...1488				

Ordering example :

5 pcs KS 03050 K400 (Item number 18.11.1487)

*) V = Packing quantity /
V = Verpackungsmenge /
V = Quantité d'emballage

Your notes

Ihre Notizen

Vos notes